

SOLTAIRE 250

TOP HUNG STRAIGHT SLIDING DOOR SYSTEM FOR DOORS UP TO 250kg EACH

APPLICATIONS

- ▶ Manufactured from high grade 316 stainless steel within anodised aluminum track.
- ▶ This reliable system is extremely durable and ideal for coastal applications or heavy use.
- ▶ Ideal for areas requiring a high level of corrosion resistance.
- ▶ Designed for interior and exterior doors up to 250 kg.
- ▶ Ideal for residential or commercial applications.
- ▶ Designed to accommodate multiple doors which can slide to either side or all to the same side.
- ▶ Hangers available for timber or metal doors.
- ▶ The track can be soffit fixed or face fixed to give flexibility of installation.

DOOR SPECIFICATION

Maximum panel weight	250 kg
Maximum panel thickness	48mm
Minimum panel thickness	35mm
Maximum panel height	3300mm

GEAR SPECIFICATION

Track	Anodised aluminium (25 microns) available in lengths <i>Soffit fix spacing 900mm centres (maximum)</i>	250/2000, 250/2500, 250/3000, 250/4000, 250/5000 & 250/6000
Brush strips	Available in black in 4 brush heights, by the metre	BS10, BS15, BS20, BS25(mm)
Brackets	Face fixed stainless steel Double face fixed stainless steel bracket (heavy) <i>Starting 20mm from end of track fix at 900mm centres (maximum)</i>	1/SS 5H/SS
Hangers	2 required per door Timber doors - corner plate fixing - saddle plate fixing - (concealed) plate fixing Metal doors - angle frame door fixing - box frame fixing - (concealed) plate fixing	52/250/SS 53/250/SS 57/250/SS 56/250/SS 56X/250/SS 57/250/SS
Guides	Timber doors - (concealed) fixing with SS bearing - wall mounted guide - for multiple runs of doors use Metal doors - box section metal door - angle frame guide	106H SS/94 102 SS/94 102 SS/94 104 PX/89 104 P/89
Channels	Aluminum (2000, 2500, 3000 & 6000mm) Stainless steel (3000mm length only) Brass (1500mm and 3000mm length only) Galvanised steel (1800, 2000, 2500 & 3000mm) Polypropylene channel Aluminum supporting channel for polypropylene <i>- Can be used with 97 galvanised steel channel for heavier doors</i>	94X 89SS 94 89 94P 94SC

Track Stop HH5/SS

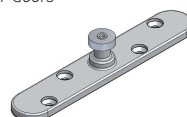

106H SS/94
(Guide)

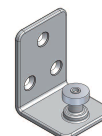

102 SS/94
(Guide)

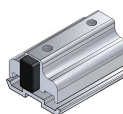

1/SS
(Bracket)

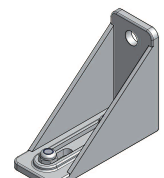

5H/SS
(Bracket)

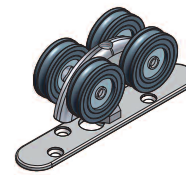

57/250/SS
(Concealed Plate fixing)

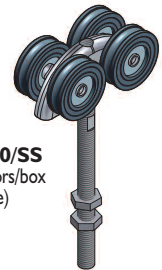

56X/250/SS
(Metal doors/box frame)

56/250/SS
(Metal doors/angle frame door fixing)

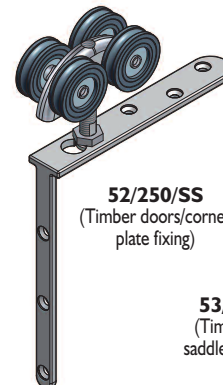

52/250/SS
(Timber doors/corner plate fixing)

53/250/SS
(Timber doors/saddle plate fixing)

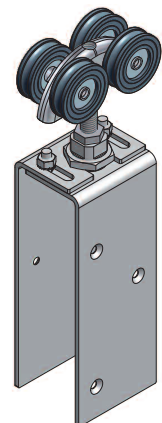

HH5/SS
(Track stop)

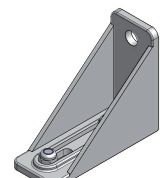
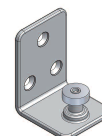
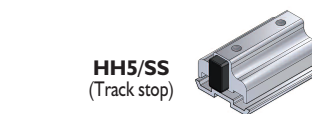

102 SS/94
(Guide)

1/SS
(Bracket)

5H/SS
(Bracket)

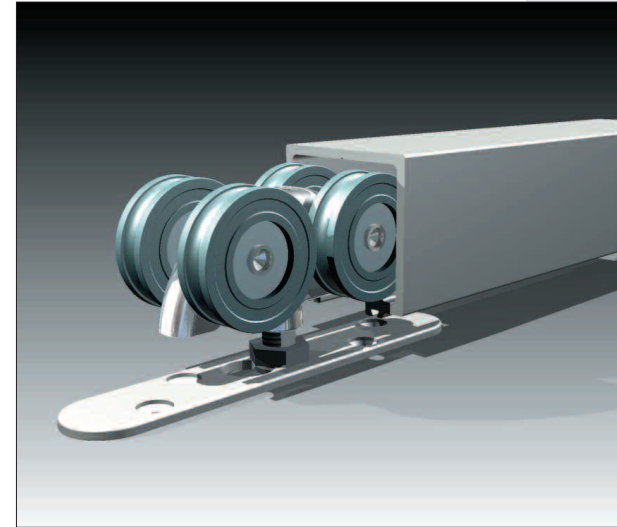

SOLTAIRE 250

